



Custom Products & Services, Inc.

6140 Claude Way E.

Inver Grove Heights, MN. 55076

PH: 888-444-1202 (Toll Free) or 651-452-0113 FAX: 651-452-2264

E-MAIL: info@custom-products.com

WEBSITE: www.custom-products.com

"Your source for workplace solutions"

ORDER GUIDE

TRACK MOUNT SYSTEM



Configurations

TRACK MOUNT SERIES

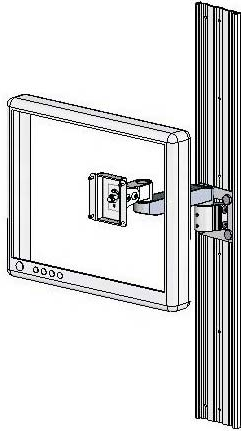

#60221 LCD track mount

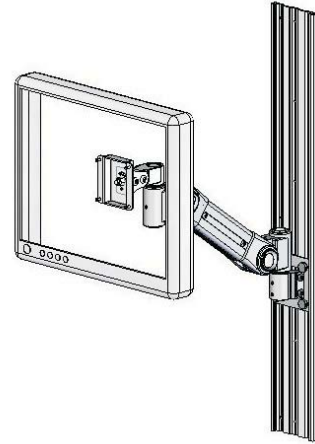

#60212 Track mount LCD adjustable arm

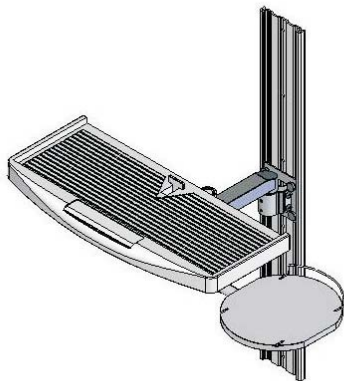

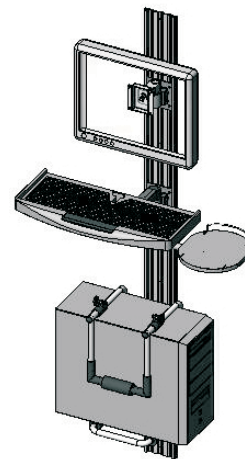

#60218 keyboard holder track mount







Track mount LCD/KB/CPU total solution





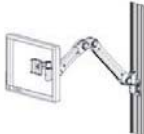

Configurations

Configurations	Part Selections	Part Numbers	Descriptions
Slim LCD track mount  #60260K Slim LCD track mount		#21-21-1B	VESA 75 track mount sliding adapter kit
	1. adapter		
	2. VESA conversion kit	#21-02	VESA 75 to VESA 100 conversion kit
	3. Sliding base	#25-50	Track mount sliding base
	4. Track	#25-50-13	Aluminum alloy extrusion track (32" long)
Compact LCD track mount  #60216K Compact LCD track mount  #60216 Compact LCD track mount		#21-01	VESA 75mm pivot bracket
	1. Pivot head	#21-01H	Heavy duty pivot bracket (VESA 75mm)
		#21-21Q	pivot adapter VESA 75 track mount quick release
	2. VESA adapter	#21-02	VESA 75 to VESA 100 adaptor plate
	3. Sliding base	#25-50	Track mount sliding base
	4. Track	#25-50-13	Aluminum alloy extrusion track (32" long)



Configurations



Configurations	Part Selections	Part Numbers	Descriptions	
Track mount extended LCD  #60215K track mount extended LCD arm	1. Pivot head	#21-01	VESA 75mm pivot bracket	
		#21-01H	Heavy duty pivot bracket (VESA 75mm)	
		#21-21-1B	VESA 75 track mount sliding adapter kit	
		#21-21Q	VESA 75 track mount quick release pivot adapter	
 #60215K track mount extended LCD arm	2. VESA adapter	#21-02	VESA 75 to VESA 100 adaptor plate	
		3. Extended arm	#22-03-1	Short extension arm (10" L)
			#22-03-2	Long extension arm (18", L)
 #60212K track mount adjustable LCD arm	4. Adjustable arm	#22-06-1	Die casting swing arm (6 ½" L)	
		#22-04-3	Adjustable arm, 15" L / (5.5 - 15 lbs.)	
		#22-04-5	Adjustable arm, 15" L / (16 - 28 lbs.)	
 #60226K track mount foldable LCD arm	5. Foldable arm	#26-31-52	Dual Adjustable Arm, 39-3/8" L Weight capacity: 2-11 lbs.	
 #60606K track mount CPU holder	6. Sliding base	#25-50	Track mount sliding base	
	7. CPU/UPS holder	#60606	Vertical surface mount CPU/UPS holder	
	8. Track	#25-50-13	Aluminum alloy extrusion track (32" long)	

Configurations

Track mount Configurations	Part Selections	Part Numbers	Descriptions
 <p>#60215K track mount compact keyboard arm</p>	<p>1. Tray pivot bracket</p>	#21-14	Fold up tray pivot unit
 <p>#60215K track mount compact keyboard arm</p>	<p>2. Platforms</p>	<p>#24-06 #24-07 #24-21 #24-31P #P24-12-10</p>	<p>Laptop Clamp Platform (#P-24-12 Mouse Tray Available) Keyboard Clamp (Includes mouse tray & gel wrist rest) Laptop Platform (12" x 15") (Optional Mouse Tray available) Phenolic Keyboard platform + mouse tray + gel wrist rest Optional Mouse Tray for #24-06 & #24-07</p>
 <p>#60218K track mount adjustable KB arm</p>	<p>3. Extension arms</p>	<p>#22-03-1 #22-03-2 #22-06-1</p>	<p>Short extension arm (10" L) Long extension arm (18" L) Die casting swing arm (6 1/2" L)</p>
 <p>#60218K track mount extended keyboard arm</p>			
 <p>#60239-K track mount Extended LCD/KB</p>	<p>5. Sliding base</p>	#25-50	Track mount sliding base
 <p>#60239-K track mount Adjustable LCD/ KB</p>	<p>7. Track</p>	#25-50-13	Aluminum alloy extrusion track (32" long)

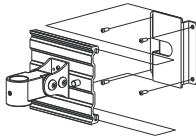
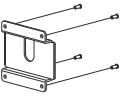
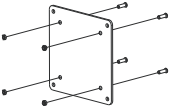
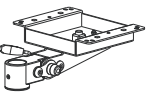
Part information

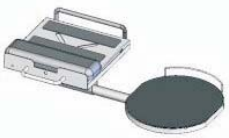
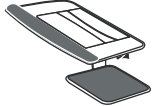
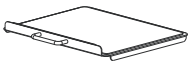
Parts	Part Numbers	Description
Pivot Head & VESA Adpater		
	#21-01	VESA 75 pivot bracket (max. load up to 24 lbs.)
	#21-01H	Heavy duty pivot bracket (VESA 75) (max. load up to 28 lbs)
	#21-21-1B (Available 6-2008)	VESA 75 track mount sliding adapter kit
	#21-21-1B	VESA 75 track mount quick release pivot adapter
	#21-02	VESA 75mm to VESA 100mm adaptor plate
	#21-14	Fold up tray pivot unit

Platforms		#24-06	Laptop Clamp Platform (#P-24-12 Mouse Tray Available)
		#24-07	Keyboard Clamp (Includes mouse tray & gel wrist rest)
	#24-31P	#24-21	Laptop Platform (12" x 15") (Optional Mouse Tray available)
		#24-31P	Phenolic Keyboard platform + mouse tray
	#24-06	#P24-12-10	Optional Mouse Tray for #24-06 & #24-07

Extension Arms

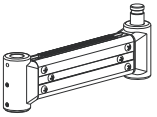
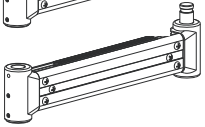
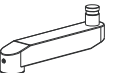
	#22-03-1	#22-03-1	Short extension arm (10")
	#22-03-2	#22-03-2	Long extension arm (18")
	#22-06-1	#22-06-1	Die casting swing arm (6 1/2")

Adjustable Arms

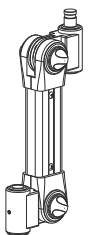

#22-04
series

#22-04-3	Adjustable Arm, 15" L (weight capacity 5.5 - 15 lbs)
#22-04-5	Adjustable Arm, 15" L (weight capacity 16-28 lbs.)

Part information

Parts	Part Numbers	Description
-------	--------------	-------------

Foldable arm

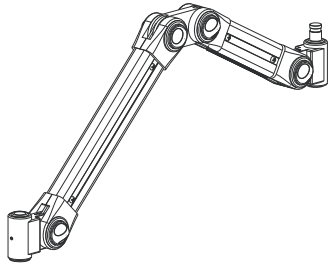

#26-31-52

#26-31-52 Dual Adjustable Arm, 39-3/8" L
Weight capacity 2-11 lbs.

Sliding Base

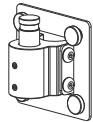

#25-50

#25-50 Track mount sliding base

CPU/UPS holder

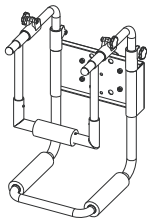

#60606

#60606 Vertical surface mount adjustable CPU holder (for pole/track/wall mount)

Aluminum Track

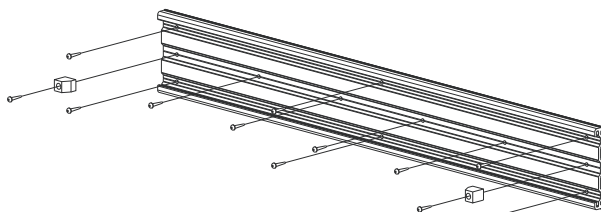

#25-50-13

#25-50-13 Aluminum extrusion track (32" long)
